

# KCM-XJ4W

KCM-XJ4  
PID

4

4

1 CU50 -50.0 150.0 Pt100 -199.9 600.0  
 K 0 1300 E 0 700.0 J 0 900.0 S(0 1600 )  
 2 PID  
 3 4-20mA  
 4  
 5 AC85 242V 50/60Hz 5W  
 6 0~50 85 RH

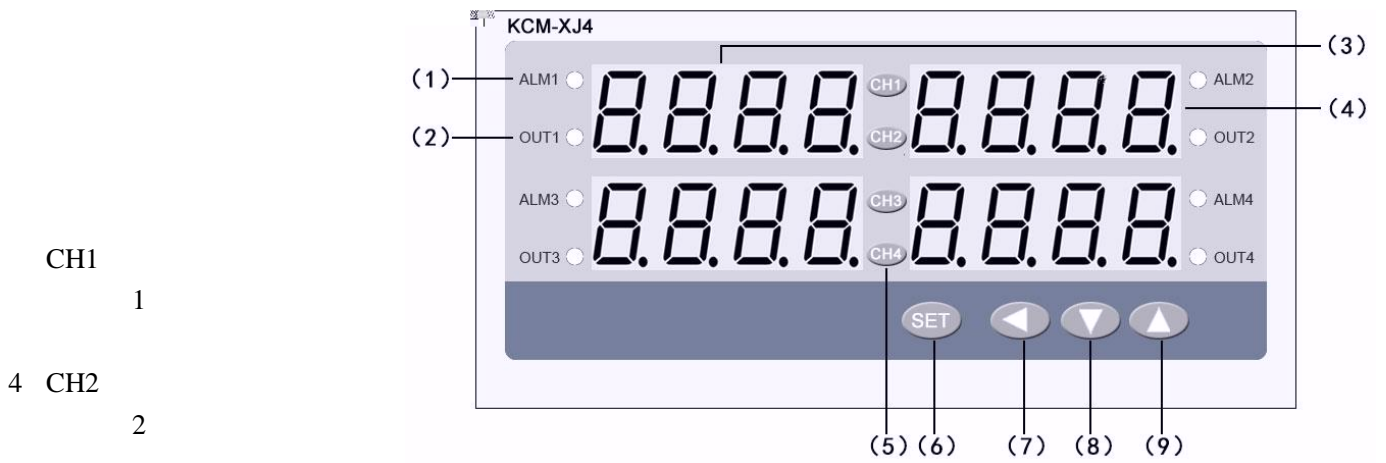

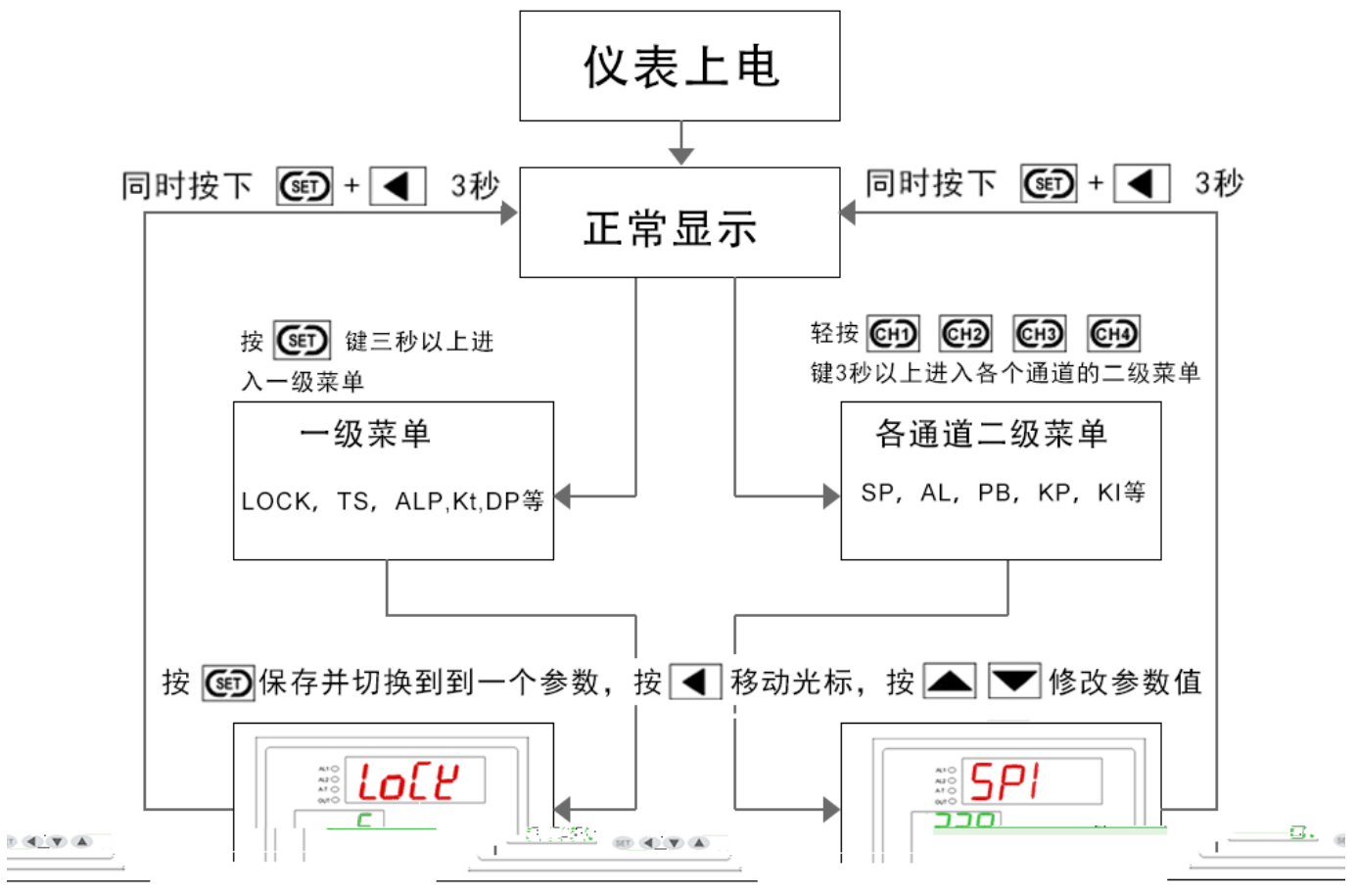
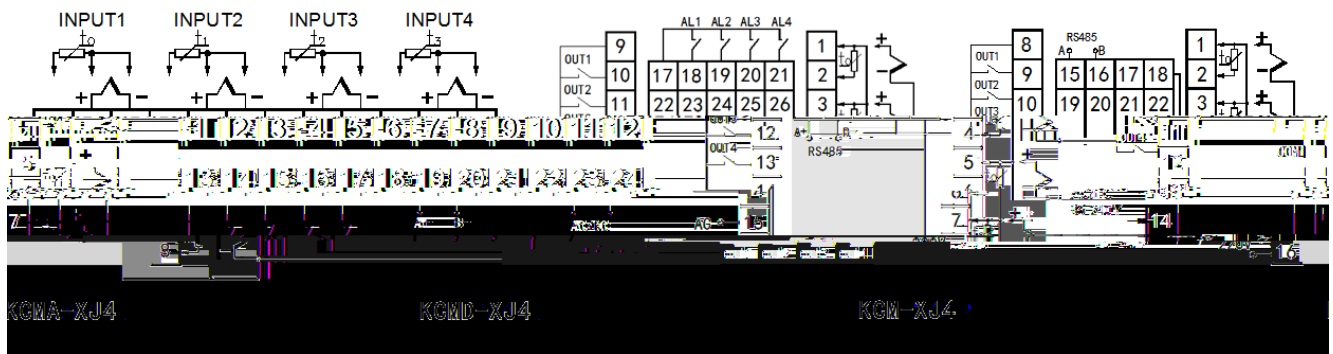

1

SET

3

1

2

		1-4		SET		
0	LoCE		0 50	18	18	18
1	ES		-	CU50(ES) PT100(PEZ) K(E) E(E) J(J) T(E) S(S)		K(E)
2	ALP		0 6	0 1 2 3 4 5 6		1
3	ET		0 120 S	2S	20S	10 S
4	dP		0~1	0. ; 1.		0
5	PS-H				SP AL	
6	PS-L					
7	oP-b		0~2	0. 1.RS485/RS232		0
8	Addr		0 255			1
9	bAud		0 3	0 1200 1 2400 2 4800 3 9600		9600
		1-4		SP 1	SP1 2	SP2
10	SP		P-SL P-SH			
11	AL			AL-P		
12	Pb		-20.0 20.0			0
13	EP		0 100	P=0 , , P , 5-2		8
14	■		0 3000			240
15	Ed		0 200S			30
16	HY		0.1 50.0			1.0
17	AL		0~1	0: 1:		0
18	CoL		0~1	0: ; 1:		0

5-2

OUT			
		OUT	OUT
	EP =0; CoL =0;	SP + HY	SP - HY
	EP =0; CoL =1	SP - HY	SP + HY



8-1

R	b	c	d	E	F	G	H	I	J	K	L	n
n	o	p	q	r	S	t	u	y				

第一步：修改仪表输入类型

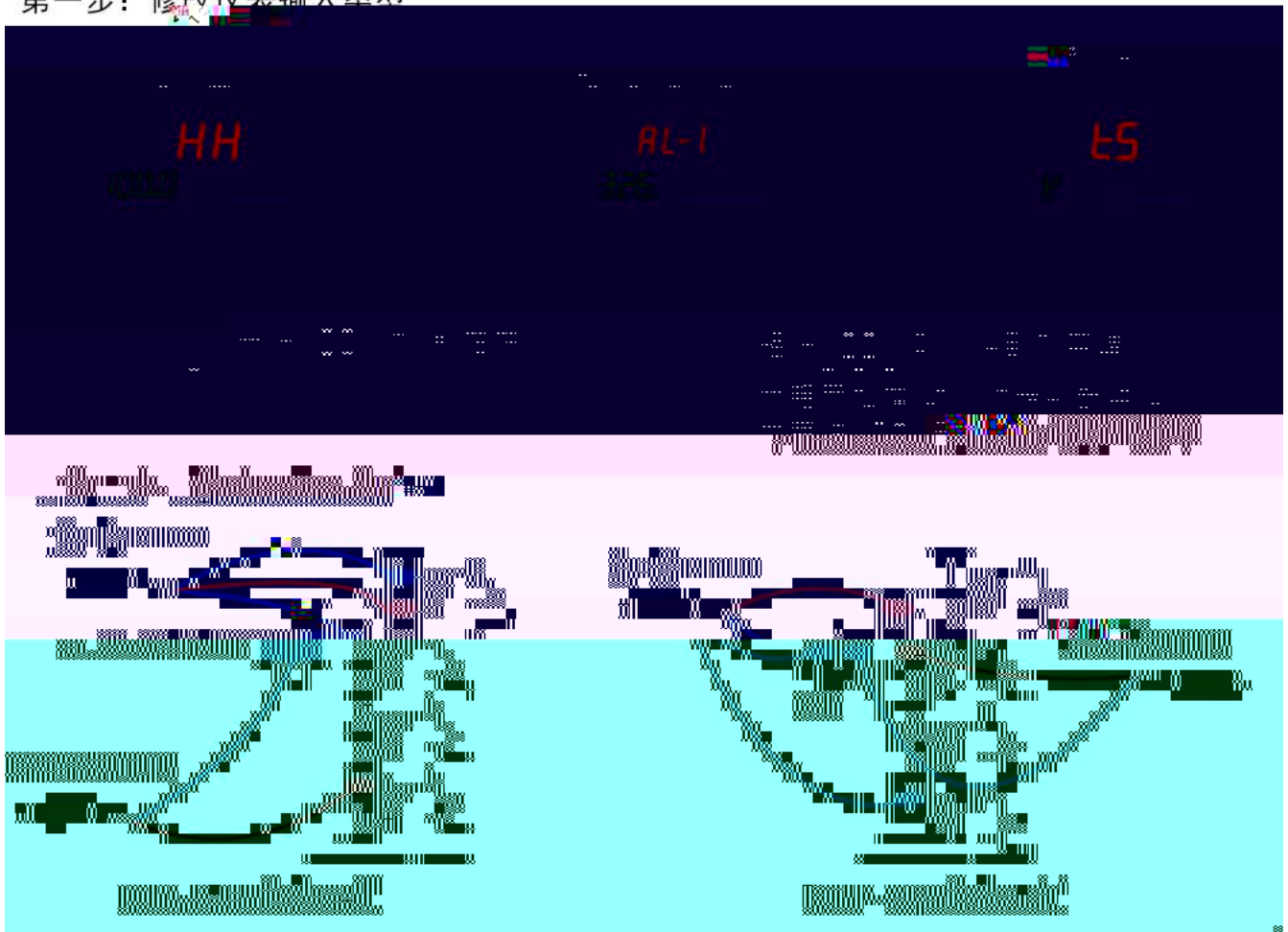

三线制PT100/CU50接线方法

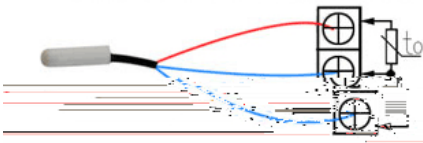

二线制PT100/CU50接线方法

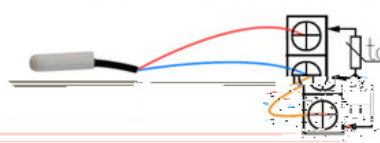

热电偶K/E/J/T/S接线方法

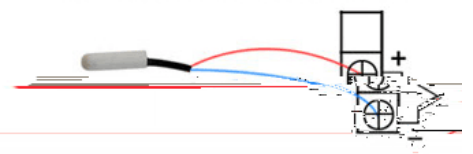

KCM KCMR 系列温控仪接线示例

中间继电器接线方法

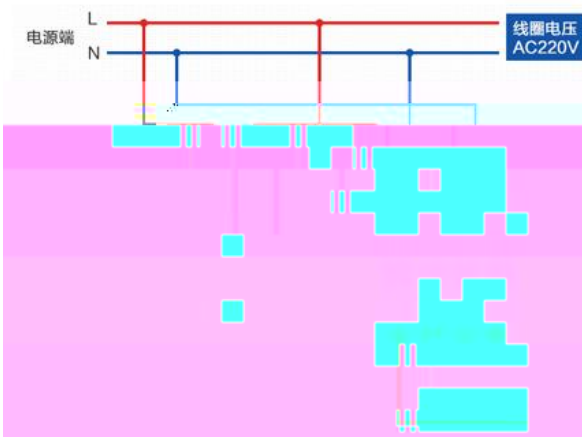

固态继电器接线方法

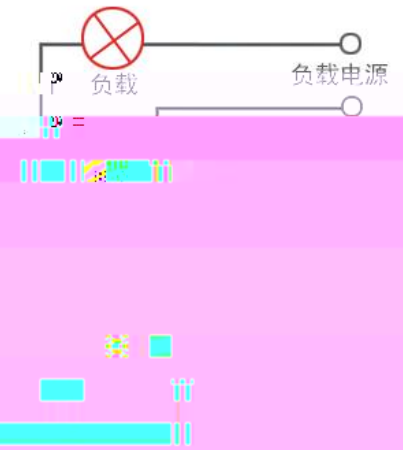

OUT ALM 继电器接中间继电器示意图

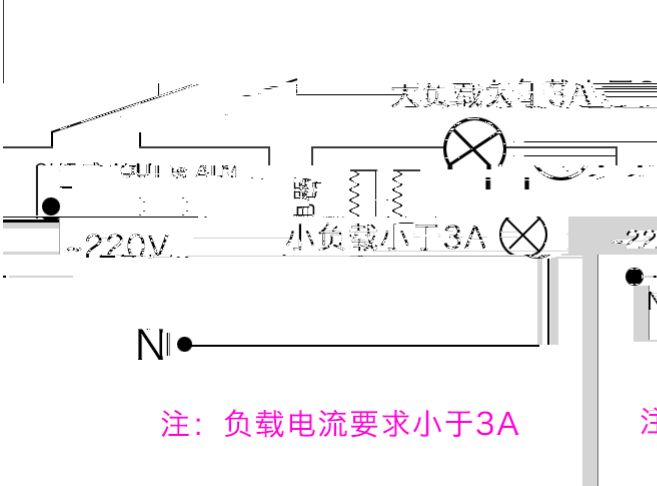

注：负载电流要求小于3A

OUT ALM 继电器接负载示意图

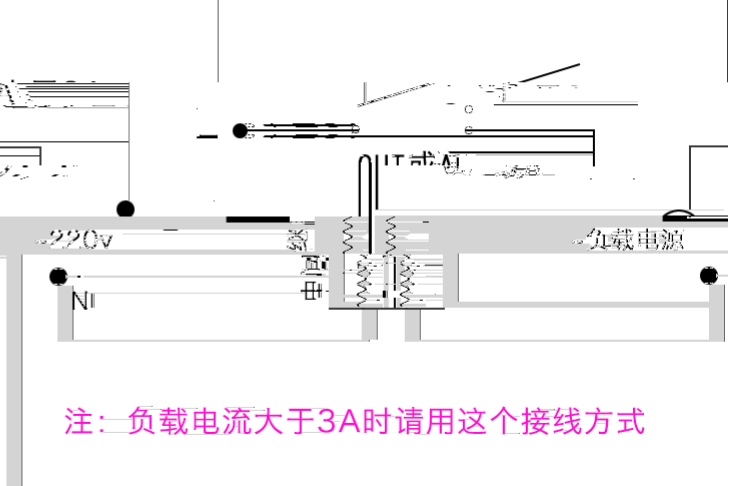

注：负载电流大于3A时请用这个接线方式

1	PC	PLC		RS485	RS232		255	
2	1	1200	2400	4800	9600	1	8	1







5-1			
Lock	NO	0000H	40001
TS	NO	0001H	40002
BAUD	NO	0009H	40010
1                      5-1			
<i>SP</i> 1	YES	000AH	40011
<i>AL</i> 1	YES	000BH	40012
<i>Pb</i> 1	YES	000CH	40013
<i>EP</i> 1	YES	000DH	40014
<i>El</i> 1	NO	000EH	40015
<i>Ed</i> 1	NO	000FH	40016
<i>HY</i> 1	YES	0010H	40017
<i>RE</i> 1	NO	0011H	40018
<i>CoL</i> 1	NO	0012H	40019
2                      5-1			
SP2~ COL2	-	0013H~001BH	40020~40028
3                      5-1			
SP3~ COL3	-	001CH~0024H	40029~40037

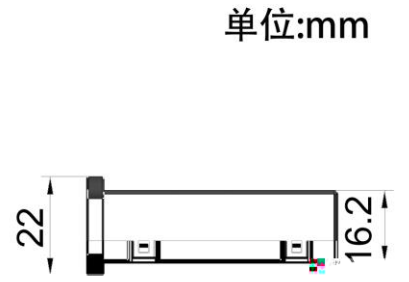
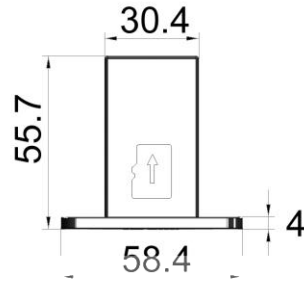
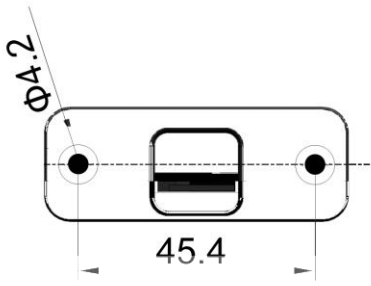

*Addr*

3-1

1	<i>YEAR</i>	YEAR			2000 2099	
2	<i>MONTH</i>	MTH			00 12	
3	<i>DAY</i>	DAY			00 31	
4	<i>Hour</i>	HOUR			00 23	
5	<i>min</i>	MIN			00 59	

	KC	<input type="checkbox"/>	<input type="checkbox"/>	<input type="checkbox"/>	<input type="checkbox"/>	<input type="checkbox"/>	<input type="checkbox"/>
	160×80mm 96×96mm 72×72mm 88×107×59mm DIN 35	:152×76mm :92×92mm :68×68mm	M MA MD MR				
	4		XJ4				
	1			<input type="checkbox"/>	1		
	: K, E, J, R, S, T, WR25, N : 0 - 5V, 1 - 5V	: Pt100, Cu50 0 - 10mA, 4 - 20mA DC	W A M				
	0/12v 4-20mA 0-10v		4 PID	<input type="checkbox"/>	G A B		
	100 to 240V AC 24V DC 72×72			<input type="checkbox"/>	1		
	RS-485(MODBUS-RTU) RS-232(MODBUS-RTU)						RS RX LG



技术支持



皓仪牌®

HINGDEATE®